

OIL & GAS

INDUSTRIAL VALVES, ACTUATORS & ACCESSORIES



vahn-tech
international inc.



FORGED STEEL	Design Standard	Pressure Rating	Size Range
Ball Valves	API 6D / BS EN ISO 17292	Class 150 - 2500 / Class 800	½" - 2"
Gate Valves	API 602 / BS EN ISO 15761		
Globe Valves			
Check Valves			



BALL VALVES	Design Standard	Pressure Rating	Size Range
Floating Type	API 6D / API 608 / BS EN ISO 17292	Class 150 - 600	½" - 12"
Trunnion Mounted	API 6D	Class 150 - 2500	2" - 60"
Top Entry	API 6D / ASME B16.34 / ISO 14313	Class 150 - 1500	2" - 48"
Rising Stem	API 6D / ASME B16.34	Class 150 - 900	2" - 24"
3-Way / 4-Way	API 6D	Class 150 - 2500	2" - 24"



CHECK VALVES	Design Standard	Pressure Rating	Size Range
Single / Dual Flap Type	API 6D / API 594 / BS 1868	Class 150 - 900	2" - 24"
Swing Type	API 6D / ASME B16.34 / BS 1868	Class 150 - 2500	2" - 32"
Wafer Lift Type	API 6D / API 594 / BS 1868	Class 150 - 900	2" - 12"



GATE VALVES / SLAB GATE VALVES	
Design Standard	API 600 / API 6D / ASME B16.34
Pressure Rating	Class 150 - 2500
Size Range	2" - 48"

TRIPLE OFFSET BUTTERFLY VALVES	
Design Standard	API 609 / BS EN 593
Pressure Rating	Class 150 - 2500
Size Range	2" - 104"

GLOBE VALVES	
Design Standard	API 623 / BS EN 13709 / ASME B16.34 / BS 1873
Pressure Rating	Class 150 - 2500
Size Range	2" - 18"

PLUG VALVES	
Design Standard	API 6D / API 599
Pressure Rating	Class 150 - 900
Size Range	2" - 18"

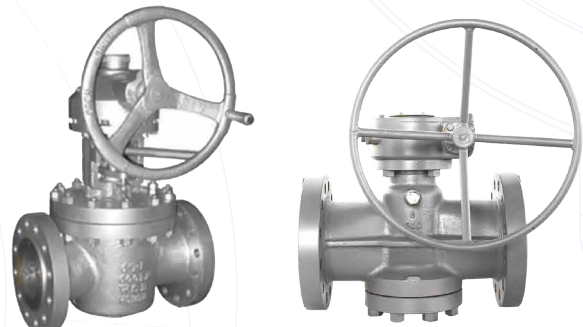
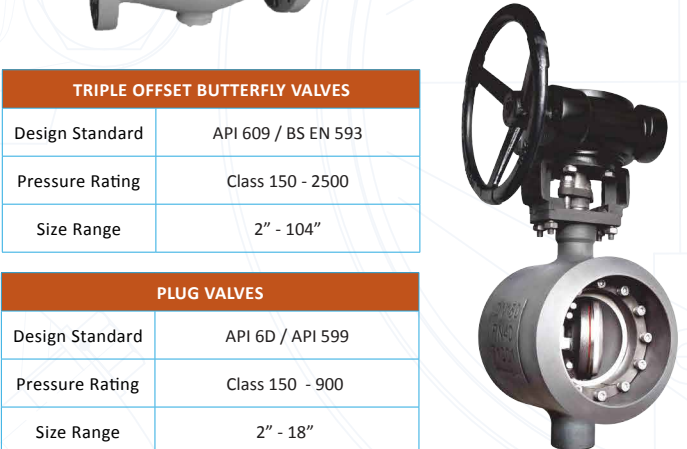
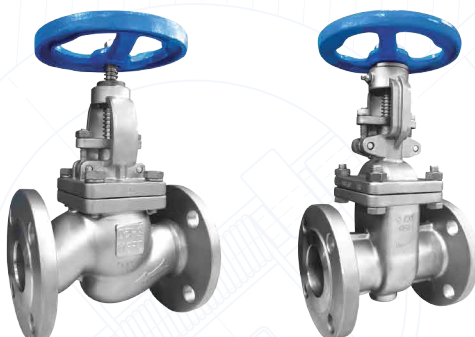
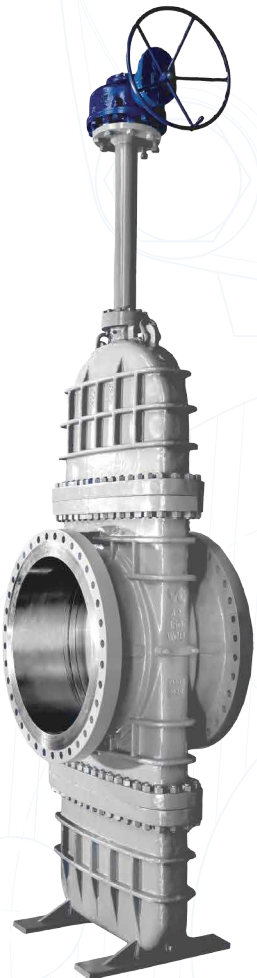

For additional options and details, please contact us.

WWW.VAHN-TECH.COM

PROCESS INDUSTRY & ACCESSORIES

INDUSTRIAL VALVES, ACTUATORS & ACCESSORIES



BUTTERFLY VALVES	Resilient Seated	PTFE Lined	Double Offset
Design Standard	API 609 / BS 5155 / EN 593	API 609	API 609
End Connection	Wafer / Lug / Flanged / Groove		
Pressure Rating	Class 150 / PN10 / PN16 / PN25	Class 150	Class 150 / Class 300
Size Range	3" - 72"	2" - 24"	2" - 72"

KNIFE GATE VALVES	High Performance Type	Slurry Type	Square Type	Through Conduit Type
Design Standard	MSS SP-81			
Pressure Rating	150 psi / 100 psi			
Size Range	2" - 72"	2" - 48"	3" - 24"	3" - 24"



STAINLESS STEEL VALVES	Ball Valves	Gate Valves	Globe Valves	Check Valves
Design	API 6D / API 608	API 600 / API 603	API 623 / BS 1873	API 6D / BS 1868
Pressure Rating	1000 psi - 3000 psi		200 psi - 1000 psi	
Size Range	¼" - 4"			

CERAMIC LINED BALL VALVES	
Pressure Rating	Class 150 / PN10 / PN16
Size Range	½" - 8"

FOOT VALVES	
Pressure Rating	200 psi
Size Range	1 ½" - 24"

DISMANTLING JOINTS	
Pressure Rating	PN10 / PN16 / PN25 / Class 150
Size Range	2" - 104"

EXPANSION JOINTS	
Pressure Rating	150 - 250 psi
Size Range	2" - 24"

Y-STRAINERS	
Pressure Rating	Class 150 - 300
Size Range	2" - 42"



For additional options and details, please contact us.

WWW.VAHN-TECH.COM

WATER & WASTE WATER

INDUSTRIAL VALVES, ACTUATORS & ACCESSORIES



WRAS APPROVED PRODUCT

CRN



BUTTERFLY VALVES	Resilient Seated	AWWA C504	PTFE Lined
Design Standard	API 609 / BS 5155 / EN 593	AWWA C504 / API 609 / MSS SP 67	API 609 / BS 5155 / EN 593
Pressure Rating	Class 150 / PN10 / PN16	150 / 250 psi	Class 150 / PN10 / PN16
Size Range	1 1/2" - 48"	3" - 72"	2" - 24"

GATE VALVES	Metal Seated	Resilient Seated
Design Standard	AWWA C500 / MSS SP-70	AWWA C509 / C515
Pressure Rating	200 / 300 psi	
Size Range	2" - 24"	2" - 72"



CHECK VALVES	Swing Type Swing Type w/ L&W	Rubber Disc Type	Ball Check Type	Dual Flap Type	Silent Type
Design Standard	AWWA C508 / MSS SP-71	AWWA C508	AWWA C508	AWWA C518 / API 6D	-
Pressure Rating	200 psi	200 psi	250 psi	Class 125 - 250	150 / 300 psi
Size Range	2" - 36"		2" - 24"		

CONTROL VALVES	Hydraulic Control Valve
Design Standard	BS EN 1074-5
Pressure Rating	Class 150 / PN10 / PN16 / PN25
Size Range	2" - 28"

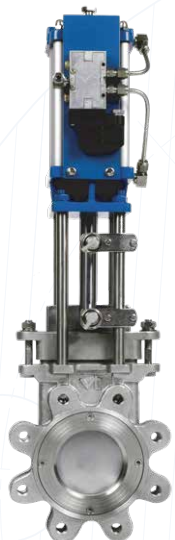

KNIFE GATE VALVES	High Performance Knife Gate Valve
Design Standard	MSS SP-81 / AWWA C520
Pressure Rating	150 psi
Size Range	2" - 48"

PLUG VALVES	Round Type	Rectangular Type
	Design Standard	AWWA C517 / MSS SP-108
Pressure Rating	175 / 250 psi	
Size Range	2" - 24"	



AIR RELEASE VALVES	Single Orifice	Combination	Sewage
Design Standard	-	AWWA C512	
Pressure Rating	200 / 300 psi	200 / 300 psi	200 psi
Size Range	1/2" - 1"	1" - 12"	2" - 8"

For additional options and details, please contact us.

WWW.VAHN-TECH.COM

ACTUATION

INDUSTRIAL VALVES, ACTUATORS & ACCESSORIES



PNEUMATIC ACTUATOR	Torque Output (Nm)		Temperature Range
	Minimum	Maximum	
Rack & Pinion	9.8	120,000	-40°C ~ +150°C
4x4 Compact	26	590	-40°C ~ +120°C
Scotch & Yoke	850	240,000	-40°C ~ +150°C

ELECTRICAL ACTUATOR	Torque Output (Nm)	Enclosure	Temperature Range	Certifications		
				CS US	CE	Ex
Quarter Turn	65 - 4500	NEMA 4X Explosion Proof	-30°C ~ +65°C	✓	✓	✓
Spring Return	50 - 260		-30°C ~ +65°C	✓	✓	✓
Multi-Turn	40 - 2500	IP67/IP68, Explosion Proof	-30°C ~ +70°C	-	✓	✓

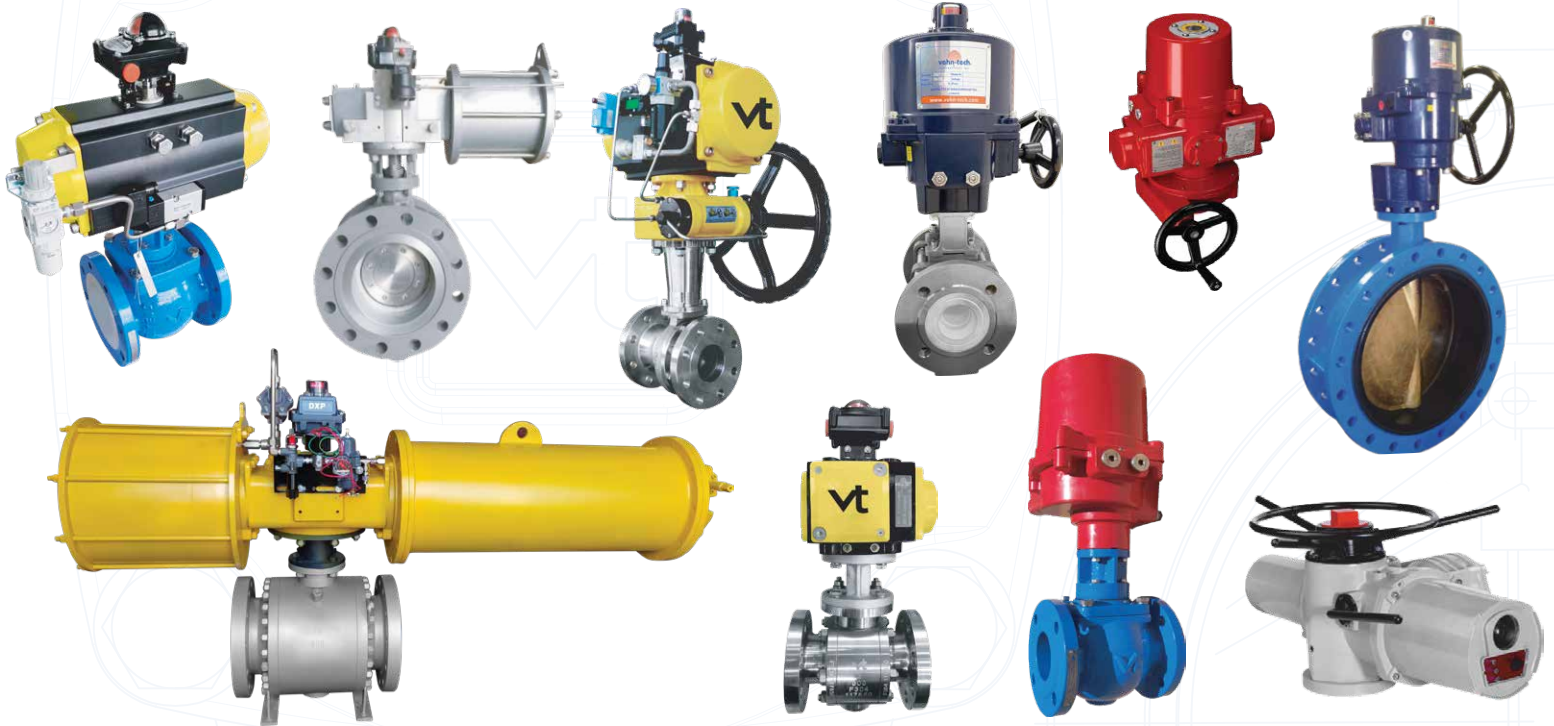

OPERATION ACCESSORIES

A wide range of actuation solutions to fit any installation requirements.

- Chainwheel
- Extension Stem (Single Driver / Torque Tube)
- Extended Bonnet
- Floor Stand
- Valve Box

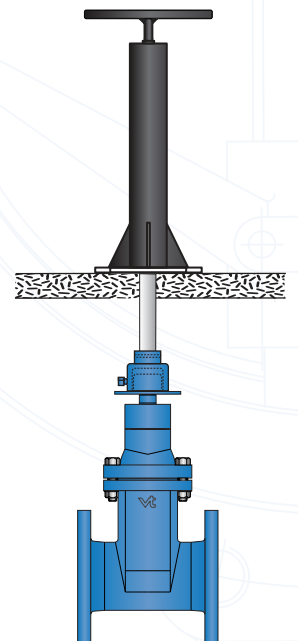
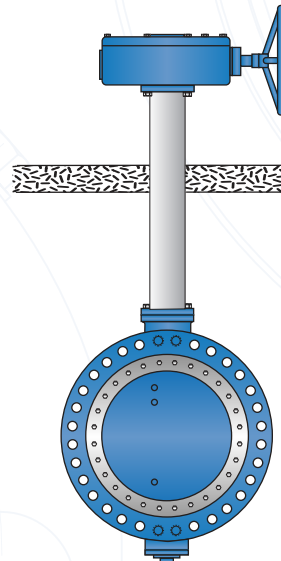
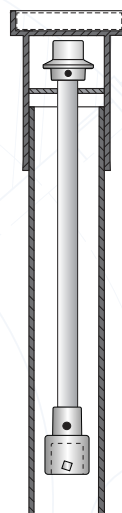
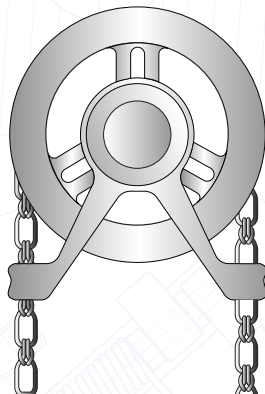

For additional options, please contact us.

WWW.VAHN-TECH.COM